

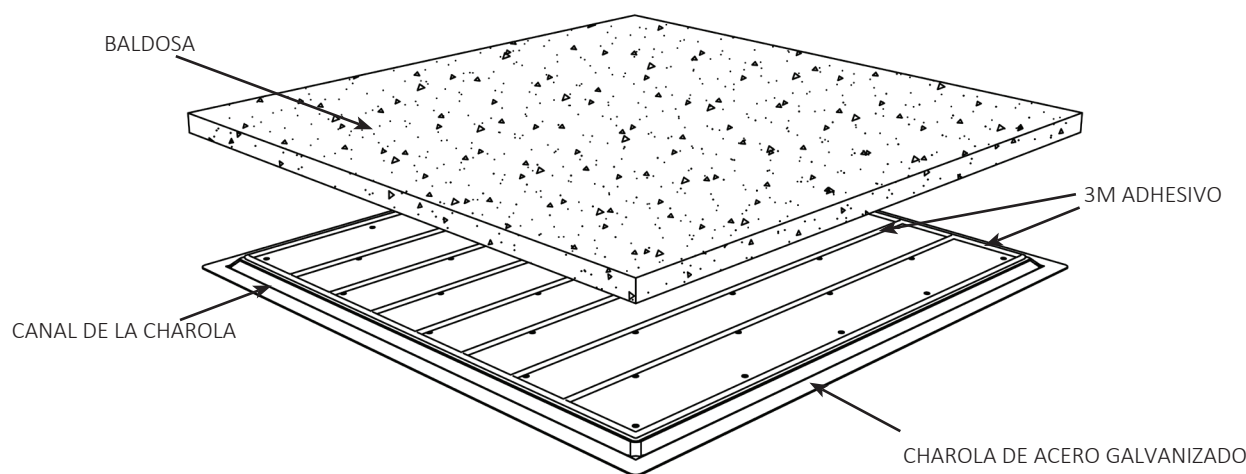

Charola para baldosas Bison Montaje y Guía de Instalación

Diseñada para usarse con pedestales Bison, la charola para baldosas ofrece un respaldo simple y liviano para mejorar la resistencia al impacto adicional a los materiales de la cubierta en áreas al exterior. Las charolas para baldosas cumplen con los requisitos de prueba de superficie no combustible de la norma ASTM E136 y son fabricadas en EE.UU con acero galvanizado resistente a la interperie. La charola se puede adherir a las baldosas antes y/o durante la instalación.

Se recomienda el uso con pedestales en un rango de alturas de 1/8" a 36", las charolas se sujetan a los pedestales Bison de 1/2" de alto a más con la Tira de sujeción FS-12. El tamaño estandar de la charola para baldosas es de 595 x 595 mm y es compatible con baldosas cuadradas de la siguiente medida 595-603 mm x 595-603 mm.



Adherivo para charolas

Bison recomienda el uso del adhesivo 3M adhesive. Existen tubos en cartuchos de 310mL y salchichas de 600mL como se muestra a continuación. Asegurese de utilizar el aplicador correspondiente, ya que puede variar entre las diferentes presentaciones.

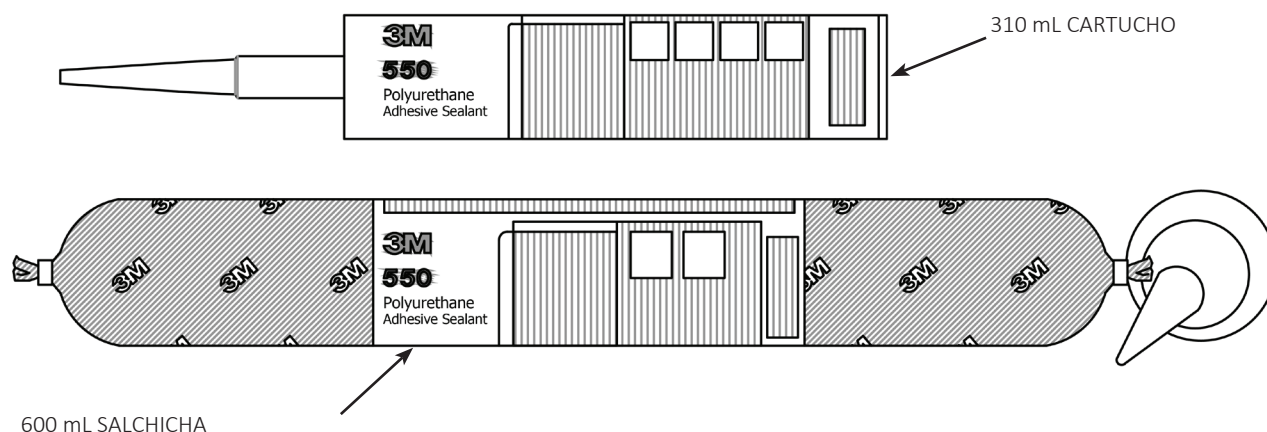

*Sistema de charolas y baldosas de 2CM de Bison (no probado para uso con otros espesores de baldosas u otro manterial de cubierta)

©2018-2021 United Construction Products, Inc. All Rights Reserved.
Covered by one or more patents or pending patents.

Cantidades de adhesivo

Utilice la tabla a continuación para determinar la cantidad de charolas que se pueden instalar dependiendo del tamaño del tubo de adhesivo.

MODELO DE CHAROLAS PARA BALDOSAS (TAMAÑO)	SE AJUSTA A BALDOSAS DE 2 CM DE ESTOS TAMAÑOS	CHAROLAS POR TUBO DE 310 ML **	CHAROLAS POR TUBO DE 600 ML **
PT-2424-4 (24"x24")	595-603mm x 595-603mm	6	12
PT-2412-4 (24"x12")	595-603mm x 295-303mm	11	22
PT-2416-4 (24"x16")	595-603mm x 395-403mm	9	18
PT-2418-4 (24"x18")	595-603mm x 445-453mm	8	16
PT-1818-4 (18"x18")	445-453mm x 445-453mm	10	20
PT-2020-4 (20"x20")	495-503mm x 495-503mm	8	16

* EL TAMAÑO DE LAS CHAROLAS PARA BALDOSAS ES NOMINAL

** ESTAS CIFRAS SON APROXIMADAS, BASADAS EN ELAS RECOMENDACIONES DE 1/8" DIA. DE ADHESIVO.

Tamaños estándar de las charolas para baldosas

Confirme los tamaños de las baldosas en unidades métricas (mm) antes de comprar las charolas. Las charolas se puede combinar para ajustarse a baldosas de gran formato.

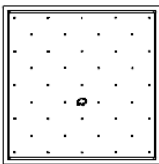
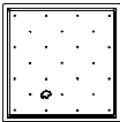
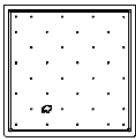
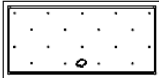
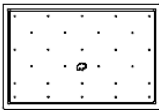
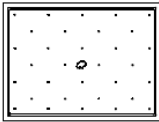
CHAROLA	MODELO	DIMENSIONES	SE AJUSTA A BALDOSAS DE 2 CM	PESO CON ADHESIVO
	PT-TRAY-2424-4	23.43" x 23.43" x 0.35" (595 x 595 x 9mm)	595 - 603mm x 595 - 603mm	6.02 lbs (2.73 kg)
	PT-TRAY-1818-4	17.52" x 17.52" x 0.35" (445 x 445 x 9mm)	445 - 453mm x 445 - 453mm	3.38 lbs (1.53 kg)
	PT-TRAY-2020-4	19.49" x 19.49" x 0.35" (495 x 495 x 9mm)	495 - 503mm x 495 - 503mm	4.18 lbs (1.90 kg)
	PT-TRAY-2412-4	23.43" x 11.61" x 0.35" (595 x 295 x 9mm)	595 - 603mm x 295 - 303mm	3.01 lbs (1.36 kg)
	PT-TRAY-2416-4	23.43" x 15.55" x 0.35" (595 x 395 x 9mm)	595 - 603mm x 395 - 403mm	4.00 lbs (1.81 kg)
	PT-TRAY-2418-4	23.43" x 17.52" x 0.35" (595 x 445 x 9mm)	595 - 603mm x 445 - 453mm	4.51 lbs (2.05 kg)

* ESTAS CIFRAS REPRESENTAN EL PESO MÁXIMO, BASADOS EN LA RECOMENDACIÓN DE 1/8" DIA. DE ADHESIVO

Combinaciones de charolas para baldosad

Las charolas para baldosas de Bison se pueden combinar para soportar baldosas de 2CM de un formato más largo. Cuando se utilicen varias charolas debajo de una baldosa, se recomienda un montaje previo a la instalación. Durante la instalación, para mantener un soporte adecuado en caso de rotura, se deben de colocar un pedestal en las esquinas de cada charola. Muchas combinaciones son posibles. La tabla a continuación proporciona información sobre las combinaciones más comunes.

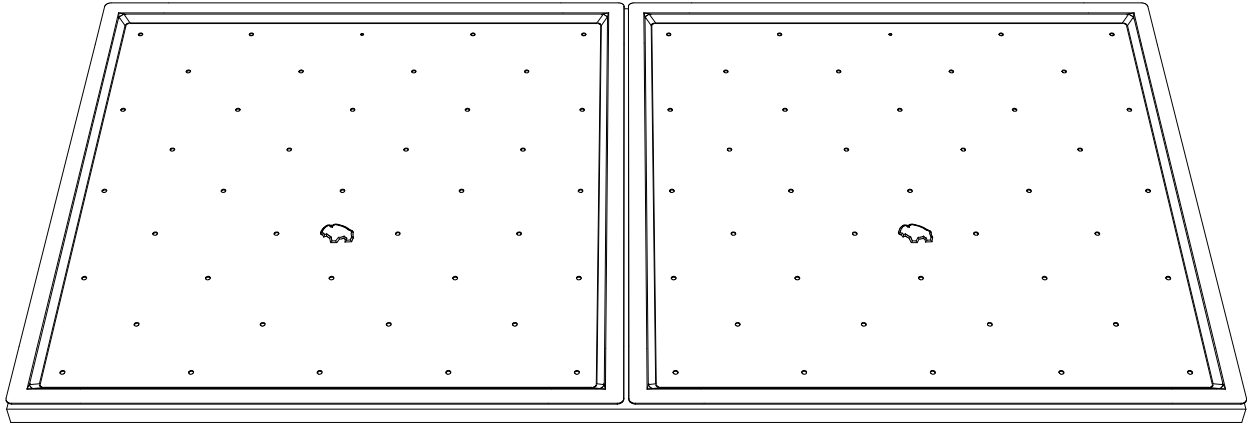

TAMAÑO DE BALDOSAS DE 2 CM *	COMBINACIONES DE CHAROLAS	TAMAÑOS DE BALDOSAS (mm)	PESO DE LA CHAROLA CON ADHESIVO
36" x 18"	(2x) PT-TRAY-1818-4	890-906mm x 445-453mm	6.76 lbs (3.07 kg)
36" x 24"	(2x) PT-TRAY-2418-4	890-906mm x 595-603mm	9.03 lbs (4.09 kg)
36" x 36"	(4x) PT-TRAY-1818-4	890-906mm x 890-906mm	13.53 lbs (6.13 kg)
40" x 20"	(2x) PT-TRAY-2020-4	990-1006mm x 495-503mm	8.36 lbs (3.79 kg)
48" x 12"	(2x) PT-TRAY-2412-4	1190-1206mm x 295-303mm	6.01 lbs (2.73 kg)
48" x 16"	(2x) PT-TRAY-2416-4	1190-1206mm x 395-403mm	8.00 lbs (3.63 kg)
48" x 18"	(2x) PT-TRAY-2418-4	1190-1206mm x 445-453mm	9.03 lbs (4.09 kg)
48" x 24"	(2x) PT-TRAY-2424-4	1190-1206mm x 595-603mm	12.04 lbs (5.46 kg)
48" x 48"	(4x) PT-TRAY-2424-4	1190-1206mm x 1190-1206mm	24.09 lbs (10.92 kg)

*EL TAMAÑO DE LAS BALDOSAS EN NOMINAL

** ESTAS CIFRAS REPRESENTAN EL PESO MÁXIMO DE LAS COMBINACIONES DE LAS CHAROLAS, BASADOS EN LA RECOMENDACIÓN DE 1/8" DIA. DE ADHESIVO

Montaje de baldosas sobre charolas previo a la instalación

Durante el montaje, limite la exposición a la humedad, luz solar directa y a temperaturas fuera de los 40°F a 100°F (5°C a 37°C).

PRECAUCIÓN; Utilice guantes cuando manipule las charolas.

1.) Paver Placement

Place paver finish face down over pedestals as shown. Pull pavers from different pallets and/or boxes in order to achieve an even color distribution.

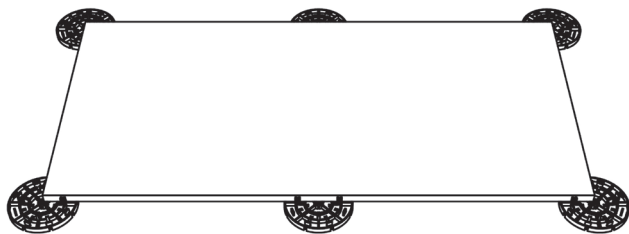

2.) 3M Adhesive

Run a 1/8" DIA. bead of provided 3M adhesive, offset 1/4" from the top outer edge of each tray, and a 1/8" DIA. bead alongside each line of holes as shown. *IMPORTANT: For proper adhesion and performance, adhesive must be applied exactly as shown. To prevent moisture from entering between paver and tray, a continuous perimeter bead of adhesive must be installed along the edge of the tray.

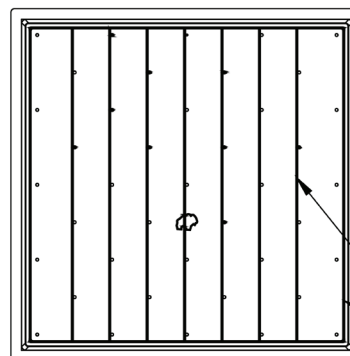

3M ADHESIVE*

Adhering a 2CM Paver to the Paver Tray Prior to Installation (continued)

3.) Paver Tray Placement

Place the adhesive side of the trays squarely onto the paver, carefully aligning by hand to make sure that the trays do not extend beyond any edge of the paver.

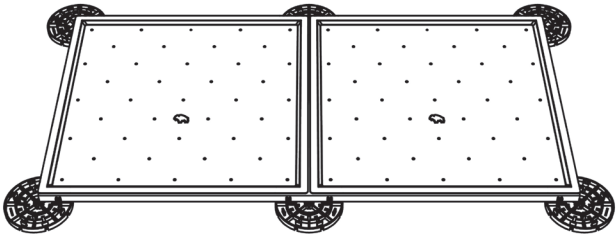

4.) Assembly Stacking

Repeating the first three steps, gently lay each new paver tray assembly on top of the previous one, rotating as shown. Stacking no more than ten (10x) paver tray assemblies high, let sit for 2 to 4 hours, or until the adhesive has cured, before handling.

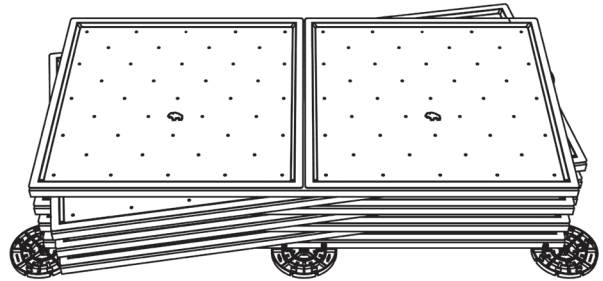

Cutting Paver Trays & 2CM Pavers

Bison Paver Trays and 2CM Pavers may be cut pre- or post-assembly. It is important to select the appropriate tools and blades before cutting the tray and paver materials.

- For extended lifespan of the cutting blade, consider using a diamond etched porcelain/ceramic blade for cutting 2CM Pavers. When cutting Paver Trays, use either a jigsaw or a steel cutting abrasive wheel. If cutting the tray before adhering, a sheet metal shear may be used.
- If cuts are to be radial or curved, score the 2CM Paver along the desired cut line, and then cut through with a smaller diameter circular blade. Scoring the paver (by itself or adhered to the Paver Tray) before cutting helps to prevent fracturing. Consider creating incremental relief cuts up to the score line if the curve causes too much stress for the blade.
- If cutting the paver BEFORE ADHERING to the tray:
 - Measure and cut the paver along the desired cut line.
 - Place the cut paver atop the tray, aligning finish paver sides with the finish sides of the tray. Trace your cut line onto the tray, and then proceed to cut the tray by itself.
 - Once cut to desired shape and size, use a metal file or angle grinder to smooth any sharp edges or burrs created along the cut line. CAUTION: Do not run your fingers along the cut line or any visible burrs.
 - IMPORTANT: Follow Bison's recommended assembly instructions to adhere the cut tray to the cut paver including the adhesive perimeter seal between tray and paver. Remove any surface debris, and if using a wet cutting technique, dry materials prior to applying adhesive.
- If cutting the paver and tray AFTER ADHERING:
 - Measure and cut the paver tray assembly along the desired cut line.
 - Once cut to desired shape and size, use a metal file or angle grinder to smooth any sharp edges or burrs created along the cut line. CAUTION: Do not run your fingers along the cut line or any visible burrs.
 - Use a small amount cleaner to remove any adhesive from the paver or saw blade, if needed. Wash with a clean rag and mild soap to remove any slippery residue.
 - IMPORTANT: It is necessary to apply a bead of the provided adhesive along any cut edges to maintain a continuous perimeter seal between the tray and paver. Remove any surface debris, and if using a wet cutting technique, dry materials prior to applying adhesive.
- Paint cut edges with a primer or cold galvanizing spray to re-administer galvanizing layer removed by cutting (exposure to heat, grinding, and/or water) to prevent rusting damage.

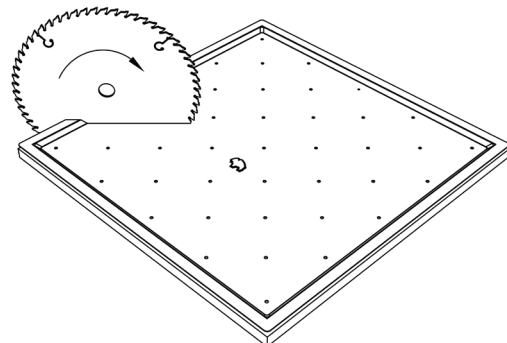

Trimmed Perimeter Paver Tray Assemblies

Cut perimeter pavers must be properly supported by pedestals. In the case of small cut paver tray assemblies around the perimeter, it may be necessary to provide support in the void created by the remaining paver tray channel. In this case, B11 and PS1 shims may be torn in half and placed in combination with one another on top of a pedestal in order to keep the paver surface level. Adhere shims to each other and to the pedestal top with construction adhesive if necessary. Pedestals may also be inverted to provide support in some circumstances. **NOTE:** See *Bison Pedestal Installation Details* for additional information.

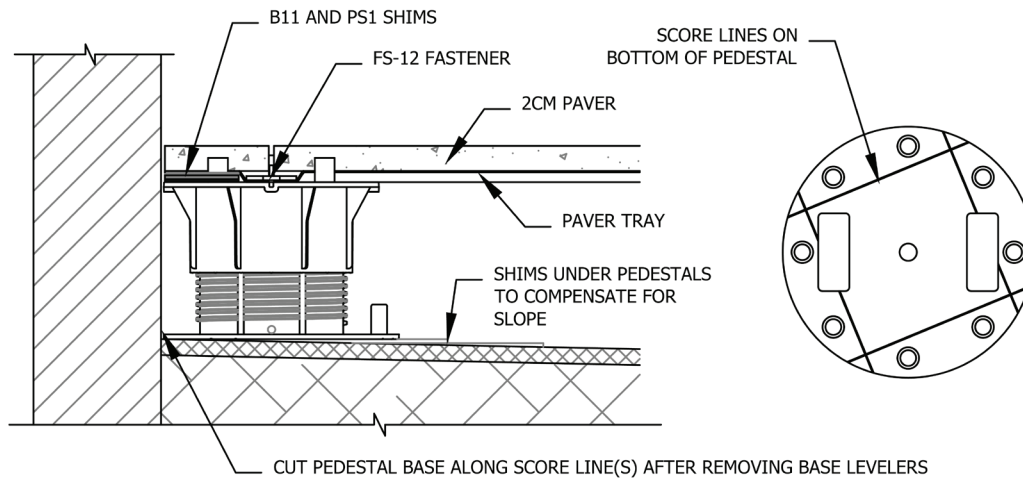

Working with Shims

PS1 - 1/8" Shims - Rigid

PS1s may be placed on top of pedestals to accommodate for minor leveling of pavers with thickness variations. Use no more than 2 shims. If using only a partial segment, adhere it to the pedestal with construction adhesive.

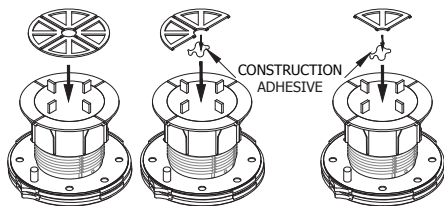

B11 - 1/16" Shims - Flexible

B11s may be placed on top of pedestals to accommodate for minor leveling of pavers with thickness variations. Use no more than 2 shims. If using only a partial segment, adhere it to the pedestal with construction adhesive.

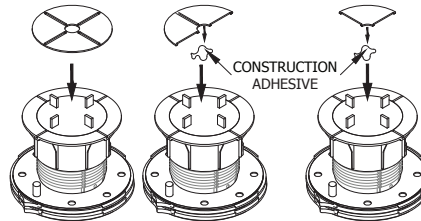

PS1 and B11 Shims Under Pedestals

Place shims (whole or in segments) under the pedestal in a stairstep fashion to compensate for sloping substrates. Use no more than 2 shims. Adhere them to each other and to the pedestal with construction adhesive. **IMPORTANT:** Do not adhere to substrate.

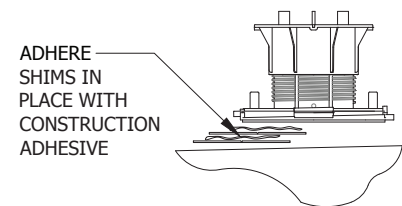

Fastening System

When using fastening components, Bison requires 3/16" spacer tabs on pedestals.

FS-12 Spline

The FS-12 Spline secures Bison Paver Trays to Bison Pedestals ranging from 1/2" to 36" in height. The FS-12 can slide along the paver tray channels to release individual pavers after installation.

When installing an FS-12, use the long screw for adjustable pedestals or the short screw for HD50 and HD75 fixed height pedestals. Using the wrong screw could cause damage to the roofing membrane. Use the spline posts to slide FS-12 splines into the channel between two adjacent paver tray assemblies. Drive the screw through the center of the screw hole and into the center of the pedestal top. Tighten until the screw head base is flush with the top of the spline rib. Remove spline posts with pliers, taking care not to damage the pavers. **CAUTION:** Do not attempt to hammer the spline posts. Use a small screwdriver to manipulate the spline if the posts have been prematurely removed.

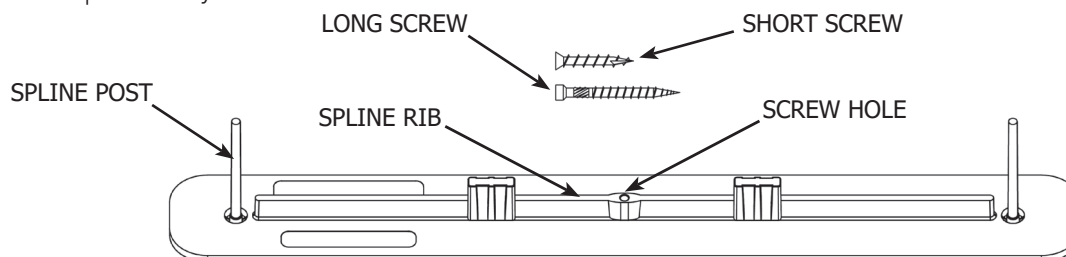

Paver Tray to Wood Tile Transitions

Bison Pedestals can support a variety of surface materials, including 2cm porcelain, concrete pavers, wood tiles, composite materials, fiberglass grating, or conventional joist and plank systems to create unique custom looks. Transitions between surface materials must be properly supported. Be sure to maintain a tight installation and limit space between surfaces.

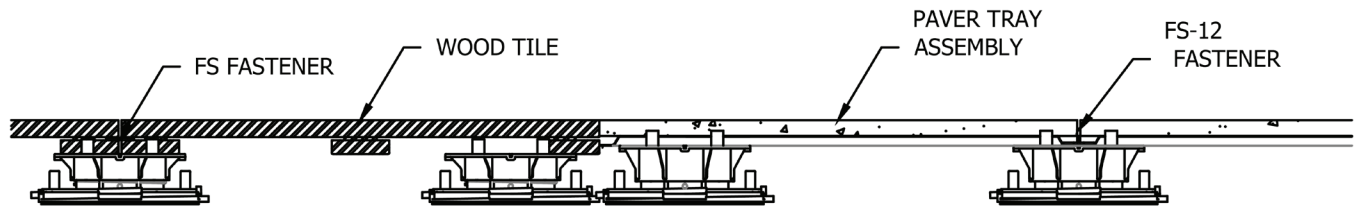

Maintenance Recommendations

Routine maintenance of your paver deck system will enhance the beauty, reduce major repairs, and prolong the life of your deck. Below is a list of maintenance guidelines that should be performed on a regular basis:

1. Check for pavers that rock. If you notice pavers rocking back and forth while walking on the deck, simply lift the paver up and shim one or more corners until the paver is level on all four corners. Bison 1/16" (1.6 mm) B11 Shims or 1/8" (3.2 mm) PS1 Shims can be used for this purpose.
2. Depending on substrate materials, some settling may occur. Remove the paver and adjust the pedestal until a level height is achieved. You may need to do this to more than one pedestal to level out an area.
3. Clean drains and scuppers on a regular basis. Water should completely drain off the roof deck within 48 hours after rainfall under ambient drying conditions. Standing or pooling water can be detrimental to some waterproofing systems.
4. Periodically check the spacer tabs between pavers, and replace broken spacer tabs immediately. Loss of spacer tabs could create unsafe deck movement.
5. There should be no more than a 3/16" (4.5 mm) gap between pavers or at any perimeter edge, and the deck should not exhibit any lateral movement which could create an unsafe condition.
6. Follow the paver manufacturer's suggestions for upkeep and maintenance of the pavers.
7. Retain extra Bison Paver Trays and pavers in a convenient location for future replacements.

Important

The Bison Paver Tray was designed to provide a simple and lightweight paver backing to enhance the collapse resistance, strength, and wind uplift performance of paver surface materials for outdoor areas. Wind Uplift Systems must be installed in accordance with separate Wind Uplift Engineering documents not included herein.

The Bison Paver Tray will not prevent any surface material from cracking, chipping, or breaking. When using Bison Paver Trays with customer supplied surface materials, including but not limited to concrete, stone, porcelain, and/or ceramic pavers not sold by Bison, the customer must independently verify surface material product strength, span rating, weight bearing capacity, material compatibility, and suitability for the intended use. In the event of surface material cracks, chips, or breaks, the Bison Paver Tray is designed to help prevent an individual from falling through the paver surface to the subsurface below. The Bison Paver Tray is intended to support the surface material after absorbing impact for a limited time. **IMPORTANT:** To avoid further damage or injury, the customer must replace any cracked, chipped, or broken surface materials and the accompanying Bison Paver Tray as soon as possible. The Bison Paver Tray is not intended to be a reusable product, and must be replaced with the surface paver.